



DEPARTMENT OF COMMUNITY DEVELOPMENT SERVICES

Planning Division

m e m o r a n d u m

TO: MOR Development Review Board

FROM: Christopher Marx, Planner I

DATE: June 23, 2016

SUBJECT: DRB-2016-01: A request by Andrew Fell, on behalf of Sohail Chaudry, to review the site plan and design of 708 and 710 West Green Street in the MOR, Mixed Office Residential Zoning District.

Introduction

Andrew Fell, on behalf of Sohail Chaudry, has requested the Mixed-Office Residential Development Review Board (MOR DRB) review the site plan and design of two proposed apartment buildings on two lots in the Mixed-Office Residential zoning district. The site consists of two lots located at 708 and 710 West Green Street, on the north side of the street between Busey and Coler Avenues. The proposed six-unit apartment buildings would replace two recently-demolished single family rental houses. The Urbana Zoning Ordinance permits multi-family uses in the MOR District by right.

Background

The applicant is seeking to construct two separate apartment buildings on the subject properties to replace the older houses which were recently demolished. The proposed building at 708 West Green Street would be three stories tall at 34.75 feet. It would contain five one- and two- bedroom units totaling 3,416 feet in floor area. The proposed building at 710 West Green Street would also be three stories tall at 34.75 feet. It would contain six one- and two-bedroom units totaling 4,035 feet in floor area.

The buildings would be designed to be similar to the other buildings on the block with traditional gables, symmetrical window openings, articulated facades, and front entrance porches. The 11 parking spaces required by the units would be located in the rear with a shared two-way driveway access.

Each building would have exterior materials designed to be durable with a traditional appearance to blend with the aesthetics of the surrounding neighborhood. Both buildings would be finished with a brick veneer base, HardiePlank lap siding, and HardieShingle siding. The roofs would have fiberglass shingles.

An 82-inch diameter underground storm sewer line runs underneath the subject property at 708 West Green Street and exists without an easement. According to the City Engineer, a ten-foot buffer is required along both sides of the sewer line for any new construction. The site plan has been designed to accommodate the sewer line buffer, creating a greater side yard setback along the eastern property line for the 708 West Green Street property. Minor variances were granted by the Urbana Zoning Board of Appeals in ZBA Cases 2016-MAJ-03 and 2016-MAJ-04 to allow the front yard setback to be 20 feet rather than the required 25 feet.

The proposed building at 708 West Green Street would be set back 25.5 feet from the front property line and 42 feet from the rear property line. It would sit 24.1 feet from the eastern property line and at least ten feet from the sewer line. The 710 West Green Street building would be set back 25.3 feet from the front property line, 43 feet from the rear property line, and 10.4 feet from the western property line. Both buildings are shown with a side yard setback of seven feet from the shared property line that divides the site.

In the MOR District, buildings taller than 25 feet require additional side yard setbacks. According to Section VI-5.F in the Zoning Ordinance, building heights in the MOR district exceeding 25 feet require an additional 3 feet of side yard setback for every ten feet in height above 25 feet. As a result of the proposed 34.75-foot building height, ten-foot side yard setbacks would be required for each side yard. A major variance for each lot would be required to allow the seven-foot side yards along the property line shared between the two lots. The Design Review Board might consider making any approval contingent upon the variances being granted.

As stated in Section IV-2, the intent of the MOR District is “to encourage a mixture of residential, office and small-scale business land uses that are limited in scale and intensity and designed and constructed to be compatible with existing structures in the district.” The MOR DRB was created “for the purpose of reviewing and approving or disapproving all site plans for new structures and land uses in the MOR District that do not incorporate adaptive re-use of an existing structure.”

Section XI-12.H.1 of the Urbana Zoning Ordinance requires that a proposed development is reviewed by the DRB within 45 working days of the application submittal. This does not preclude the DRB from continuing the case if additional time is needed to review the proposal. After completing all plan review procedures found in Section XI-12, the Development Review Board shall vote to approve the application. The DRB may impose conditions deemed appropriate to ensure compliance with the Ordinance, the intent and purpose of the MOR District, and to ensure that any development is compatible with the land uses surrounding the site.

Per the Urbana Zoning Ordinance, the Development Review Board has the following objectives when reviewing site plan proposals in the MOR District:

- a. Encourage compatibility by minimizing impacts between proposed land uses and the surrounding area; and
- b. Encourage the design of new construction to be compatible with the neighborhood’s visual and aesthetic character through the use of design guidelines; and

- c. Determine if proposed development plans meet the intent of the district as stated in Section IV-2.H.

Discussion

Zoning Analysis

Site plans must demonstrate conformance with the land use and development standards of the Urbana Zoning Ordinance. The subject property is in the MOR zoning district. The proposed use is *Dwelling, Multiple-Family*, which is permitted by right. The following chart contains a zoning analysis of the proposal and shows that the project meets all zoning requirements except for the side yard setback along the property line shared by the two subject lots, indicated in italics.

	Required/Allowed	Proposed at 708 W. Green St.	Proposed at 710 W. Green St.
Lot Size	Minimum 6,000 sq ft	6,721 sq ft	6,413 sq ft
Lot Width	Minimum 60 ft	60 ft	53 ft (legally nonconforming)
Floor Area Ratio	Maximum 0.70	0.51	0.70
Open Space Ratio	Minimum 0.30	0.30	0.30
Building Height	Maximum 35ft	34.75 ft	34.75 ft
Front Yard Setback (Avg. of block face)	Minimum 25 ft	25.3 ft	25.5 ft
Side Yard Setback	Minimum 10 ft*	East: 24.1 ft West: 7 ft	East: 7 ft West: 10.4 ft
Rear Yard Setback	Minimum 13 ft*	42 ft	43.4 ft
Parking	Minimum 1 per dwelling unit. 708 W. Green: 5 710 W. Green: 6	5	6

*In the MOR and some other districts, the required side yards and rear yards are increased by 3 feet for every 10 feet of building height over 25 feet.

Surrounding Land Uses

The site is located on the north side of the 700 block of West Green Street between Busey and Coler Avenues. It consists of two vacant lots zoned MOR, Mixed Office Residential. The neighboring property to the east is a duplex and to the west is a 5-unit multi-family building, both zoned MOR. Across the street to the south, an apartment building is zoned R-5, Medium High Density Multiple-Family Residential and is adjacent to two group homes zoned MOR, Mixed Office Residential. Toward the north and behind the subject property are two rows of townhouse-style multi-family buildings and a multi-family building zoned R-5, Medium High Density Multiple-Family Residential. The future land use designation in the City’s Comprehensive Plan is “Mixed Residential.”

Site Plan Review Criteria

Site plans (including elevations and floor plans) shall be reviewed by the Development Review Board according to the criteria found in Section XI-12.I and listed below:

1. Compatibility with Surrounding Neighborhood

Proposals shall demonstrate consistency with the intent of the MOR, Mixed-Office Residential Zoning District as stated in Section IV-2-H:

The MOR, Mixed-Office Residential District is intended to encourage a mixture of residential, office and small-scale business land uses that are limited in scale and intensity and designed and constructed to be compatible with existing structures in the district. The district is intended to encourage the adaptive re-use of existing older structures through incentives that will extend the useful life of such structures. New construction shall be designed and constructed in a manner that is consistent with the character of the district. The land uses permitted and the development regulations required in the MOR District are intended to protect nearby residential uses by limiting the scale and intensity of the uses and buildings that may locate in this district. The MOR District is appropriate for mixed uses on small sites which need a careful evaluation of use-to-use compatibility so that the stability and value of surrounding properties are best protected. (Ord. No. 2003-11-120, 11-25-03).

In reviewing proposals the Development Review Board shall consider the effects of the proposed structure and use on adjacent properties and the surrounding neighborhood. The Board shall consider building location, orientation, setbacks, scale, bulk, massing, and architectural design.

Analysis

To the east of the subject properties is a two-and-a-half story rental duplex and to the west is a three-story, five-unit apartment building of 4,745 square feet of floor area. The remainder of the block consists of two rental duplexes and a multi-family residential building, each two-and-a-half stories tall. The buildings on the block have the typical MOR district features of front entrances, gabled and hipped roofs, and lap siding. Behind the subject properties, to the north, are three multi-family buildings. Across the street, to the south, is a multi-family building with fifteen units. The surrounding area contains a mixture of single-family houses and multi-family buildings. The size and scale of the proposed buildings would be comparable to the other buildings located on the block. The proposed buildings' size, placement, and architectural features would be similar to those on the rest of the block.

2. Parking and Access

Proposals shall demonstrate that required parking areas are provided in accordance with Article VIII of the Urbana Zoning Ordinance and that parking areas and access drives are designed to move traffic conveniently and safely in a manner that minimizes traffic conflicts, noise and visual impacts, while minimizing the area of asphalt or concrete. Proposals shall demonstrate the safe and convenient movement of handicapped persons and that the location and design of handicapped parking is in conformance with the requirements of the State of Illinois. Parking areas shall be screened from adjacent residential uses.

Analysis

The proposed buildings would have a shared two-way access drive on the eastern side of the 708 West Green Street property. The access is proposed at this location as driveways are permitted to be constructed over the large storm sewer, while buildings must be built at least ten feet from the center of the storm sewer.

The off-street parking would be screened and placed behind both buildings and out of view from most angles. The proposal would meet the required number of parking spaces for six two-bedroom and five one-bedroom units, which is 11 spaces. The proposal would also meet the requirements for handicap parking and bicycle parking on the property.

3. Screening and Landscaping

Proposals shall demonstrate the preservation of existing natural features where practical. The Development Review Board shall consider the effects that the proposal may have on the vegetative characteristics of the area and may require landscaping measures to mitigate any potential loss of character. Proposals shall also demonstrate compliance with all landscape and screening requirements identified in the Urbana Zoning Ordinance. The Development Review Board shall consider landscape and screening plans and their ability to effectively screen adjacent properties from possible negative influences that may be created by the proposed use. Retention of street trees along the Green and Elm Street corridors shall be encouraged.

Analysis

The proposal would preserve a 36” maple tree in the front yard of the 708 West Green Street property. The 16” Siberian elm tree in the parkway would need to be removed to accommodate the new curbcut. The City Arborist has indicated that the tree is a poorer species with limited long-term value. If space permits, a new street tree should be planted in the vicinity. A six-foot tall cedar screening fence would extend around the rear perimeter of both subject properties. The proposal would also include a dozen shrubs surrounding the 708 West Green Street building, two dozen shrubs surrounding the 710 West Green Street building, and a raised planter box in the front.

4. Site Details

Proposals shall address the provisions for site details including exterior trash dumpsters, storage areas, loading areas, exterior lighting and signs. The Development Review Board shall determine if the site details will negatively impact adjacent properties and the character of the neighborhood.

Analysis

The proposal would contain a trash area serving both properties on the northeast corner of the 708 West Green Street Property. It would be screened from both the public right-of-way and the adjacent residential properties. The air conditioning units for 708 West Green Street would be located along the east side of the building, toward the rear and screened from the street by shrubs. The air conditioning units for 710 West Green Street would be located at the northwest corner of the building and screened from the street by the building.

The Urbana Zoning Ordinance includes mandatory design criteria as specified in Section XI-12.J. These requirements state that the front entrance must face the street, building walls facing the street must contain window openings, and that parking areas shall be located behind the principal structure. Finally, the Urbana Zoning Ordinance prohibits parking underneath any principal structure within the MOR.

Analysis

The front facades of both buildings would have front entrances and windows to provide openings and transparency. The parking would be located behind the principal structures.

MOR Design Guidelines Review and Findings

In addition to the requirements in the Zoning Ordinance, the MOR zoning district includes a number of design guidelines to be reviewed by the Development Review Board. The primary sections of the guidelines are listed below along with a staff analysis of compliance.

Façade Zone:

Strongly Encouraged

- New building additions that complement the architectural style of the main structure.

Strongly Discouraged

- The location of mechanical equipment (such as air compressors, mechanical pumps, water softeners, utility meters and the like) in the façade zone.

Analysis

The buildings are new construction so that the first criteria regarding matching the architectural style of the main structure would not apply. The street-facing facades have multiple window openings and covered, front-facing entrances. The off-street parking, at the rear of the properties, would be mostly concealed by the buildings. The air conditioning units would not be located in the front of the buildings.

Building Orientation & Patterns:

Strongly Encouraged

- Building placement and general orientation on a site that is compatible with other structures on the block.

Encouraged

- New construction projects, including additions, that incorporate common patterns and architectural characteristics found throughout in the district. (e.g. porches, roof type, openings, etc.)
- Use of architectural detailing and landscaping to help new construction "blend in" with the block.

Analysis

The buildings on the 700 block of West Green Street were built in the early-to-mid twentieth century with the exception of 712 West Green Street which was built in 1999. The proposed buildings offer similar traits as the other buildings on the block. The 710 West Green Street

building would be ten feet and six inches from the western property line and seven feet from its eastern property line. The 708 West Green Street building would be seven feet from its western property line and approximately 24 feet from its eastern property line, honoring both the storm sewer buffer area and required side yard setback. Section VI-5.F.3 of the Zoning Ordinance states that any structure in the MOR district must have an increased side yard setback of three feet for every ten feet in height over the maximum height of 25 feet. Because the buildings are each 34.75 feet tall, the applicant must seek a variance for each lot to allow a reduced side yard setback along the property line shared by the subject lots. The variance would need to allow a side yard of seven feet rather than the required ten feet to construct the project as proposed.

Both buildings would have architectural features similar to the rest of the buildings on the block. They would have pitched, shingled, roofs with gables of similar pitches as the rest of the block. They also would have front-facing entrances and small front porches. The varying shingle patterns on the different stories of the neighboring buildings to the west would be replicated on the proposed buildings. A brick veneer base on both buildings would also reflect a common element found on other buildings on the block and many buildings in the MOR district.

Massing and Scale:

Strongly Encouraged

- The "height to width ratio" of a structure is compatible with that of other structures on the block face. For example, if existing structures on a block face have a height to width ratios of 2:1, then a height to width ratio of 1:3 for new construction may not be appropriate.

Encouraged

- The use of various decorative details and exterior materials to add interest, scale, and dimension to a building.
- Height and rooflines on new construction that are compatible with other buildings found on the block face.
- A combination of rooflines with varying roof heights and pitches used to break up the mass of a structure.
- Roof pitch and shape on new construction compatible with other forms found in the district.

Analysis

The approximate height-to-width ratios for the other properties on the block range from approximately 1:2 to 1:1. The ratio for the property at 708 West Green Street would be slightly taller than a 1:1 ratio, while the ratio for the 710 West Green Street property would be about 1:1. The ratio for 708 West Green Street is higher than the range because the property's buildable area is limited by the required storm sewer easement. The ratio for the 710 West Green Street property is at the upper end of the range because the lot is legally nonconforming at seven feet narrower than the required 60 feet as required in the Zoning Ordinance, therefore limiting the buildable width.

Both of the proposed buildings would have gabled and hipped roofs and similar pitches to the buildings found elsewhere on the block. The building height of 34.75 feet would be somewhat greater than the 700 West Green Street block average, but only a few inches taller than the adjacent building at 712 West Green Street. The rear depth behind the building would not be greater than most of the existing buildings on the block.

Openings:

Strongly Encouraged

- An adequate amount of openings on a façade.
- Large wall expanses on a facade that are interrupted by windows.
- Openings that reflect the building's architectural style.

Encouraged

- Openings that are in proportion to others on the facade and are similar in size and scale.
- A consistent rhythm of openings on the facade.
- True divided-light windows.

Analysis

The proposed facades of each building have multiple windows on each floor, breaking up wall expanses and designed to be consistent with the buildings' architectural styles. The divided-light windows would be generally symmetrical, proportional, and of similar dimensions. The facades that face one another would have minimal openings, but the openings are placed closer to the street on these elevations to break up the most visible portions of the facades when viewed from the public right-of-way.

Outdoor Living Space:

Strongly Encouraged

- Front porches and balconies with rooflines that are compatible with the main roof of the structure.
- Outdoor living spaces that use a variety of styles and materials in order to complement the overall composition of the building.

Encouraged

- Buildings on corner lots with porches and/or stoops located on both facades
- Porches on new residential construction. Flat porch roofs that serve as covered balconies for the second floor.
- Balconies on multi-family residences located above the first floor only.

Discouraged

- Terrace-like patios located in the façade zone (for residential uses)

Strongly Discouraged

- Balconies directly abutting single-family residences

Analysis

Each building proposes a covered front porch with rooflines compatible with the main roof structure. No balconies or terrace-like patios are proposed. Most outdoor living space is located in the front yard.

Materials:

Strongly Encouraged

- Long-lasting and durable exterior materials such as brick and wood clapboard.
- Exterior treatment or siding that protects the integrity of the structure and provides an enhanced visual aesthetic to the block.

- Recognition of the diversity of materials used throughout the district and the importance of material quality.

Encouraged

- Roof materials that are compatible with those found within the district. In the case of new additions, roof materials that complement those found on the main structure.

Analysis

The exterior siding of both buildings would be HardiePlank and HardieShingle siding, with a brick veneer base. The roofs of the main part of the structures would be fiberglass shingles, with metal roofs over the front porches. The materials would provide durability to the buildings while maintaining a traditional look similar to that of the block and MOR district.

Parking Areas:

Strongly Encouraged

- Utilization of existing alleyways for the purpose of access to parking areas
- Fencing and other screening elements that are architecturally compatible with the principal building in terms of material quality and detail.

Encouraged

- Screening to reduce visual impact from adjacent properties
- Use of hedges, wood fences or masonry walls used to screen parking areas from adjacent properties

Analysis

The proposal features off-street parking spaces behind both buildings that would not be highly visible from the façade zone. The spaces share an access drive on the eastern side of the 708 East Green Street building as no alley is present. A six-foot, solid cedar fence to screen the parking would begin approximately 65 feet back along the western side of the 710 West Green Street property and extend around the rear property lines of both sites, ending at the screened trash area on the northeastern corner of the 708 West Green Street property.

Landscaping:

Strongly Encouraged

- Retention of mature trees on private property and within the parkways and other City right-of-way areas. (Green and Elm Street corridors are particularly important)

Encouraged

- New tree plantings on private and public property to replenish the urban canopy.
- Protect mature trees from root damage during construction, both on the subject property and on any adjacent properties.
- Use of evergreens, dense deciduous shrubs, masonry walls and berms for screening.
- Design landscaping to ensure safe pedestrian and automobile traffic circulation on and off private property.

Analysis

A large, 36” maple tree in the front yard 708 West Green Street would be preserved in the proposal. A 16” Siberian elm street tree near the eastern edge of the site would need to be removed to

accommodate the driveway. The City Arborist has indicated that the tree is a poorer species with limited long-term value. If space permits, a new street tree should be planted in the vicinity.

An existing curbcut would be removed and the curb and parkway would be restored. Both buildings would include shrubs surrounding most of their perimeters. The site plan and renderings also indicate a raised planter box in the front. The location of the landscaping would not inhibit pedestrian or automobile circulation.

Commercial Site Design:

The proposed building is not a commercial structure; this section therefore does not apply.

Options

In DRB-2016-01, the Development Review Board has the following options:

- a. **Approve** the application;
- b. **Approve** the application along **with conditions** related to meeting the standards and design guidelines of the MOR, Mixed Office Residential Zoning District;
- c. **Continue** the case to the next meeting to request additional information from the applicant or further consider the application; or
- d. **Deny** the application. If the Board elects to do so, the Board should articulate findings supporting the denial. In the event the Board denies the application, the case may be appealed to the Urbana Zoning Board of Appeals for final approval or disapproval of the application as proposed, per Section XI-12.H.2.

Recommendation

Based on the evidence presented to date, and without the benefit of considering additional evidence that may be presented prior to or at the public hearing, staff recommends that the Development Review Board **APPROVE WITH CONDITIONS** Case DRB-2016-01 with the following conditions:

1. That construction be in general conformance with the attached Site Plan, Floor Plans, and Elevations.
2. The applicant shall obtain a variance for each lot to allow for the reduced side yard along the shared property line.
3. That the fence in the rear and side yards be an opaque wood fence of at least 6 feet in height.

The specifics of this recommendation may change during the course of formal review of Case DRB-2016-01. The staff recommendation contained herein represents the professional opinions of the City's professional planning staff and does not in any way bind or constrain the recommendations and decisions which may be made by the City's appointed and elected officials. The applicant and those interested persons who oppose the application for Case DRB-2016-01 shall have a reasonable opportunity to question City staff regarding this recommendation during any public hearing on the application at which the staff presents its recommendation.

Attachments:	Exhibit A:	Location Map
	Exhibit B:	Zoning Map
	Exhibit C:	Future Land Use Map
	Exhibit D:	Application
	Exhibit E:	Site Plan and Building Design
	Exhibit F:	Area Photos

cc: Andrew Fell
Sohail Chaudry

Exhibit A: Location & Existing Land Use Map

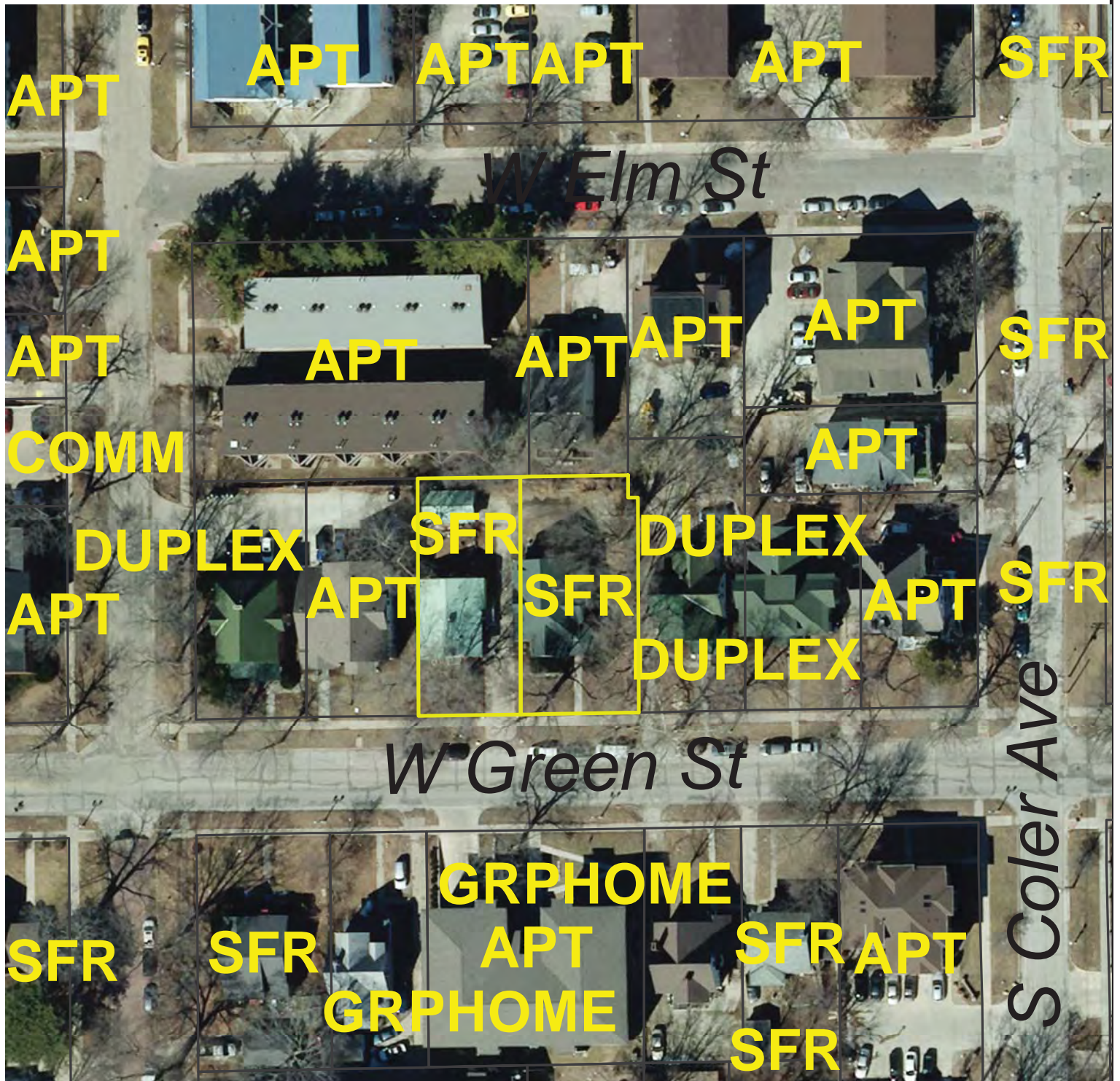

 Subject Property

Case: DRB-2016-01
 Subject: MOR Development Review Board Application
 Location: 708 and 710 West Green Street
 Petitioners: Andrew Fell

Exhibit B: Zoning Map

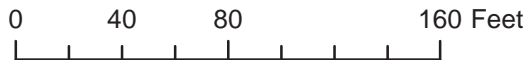
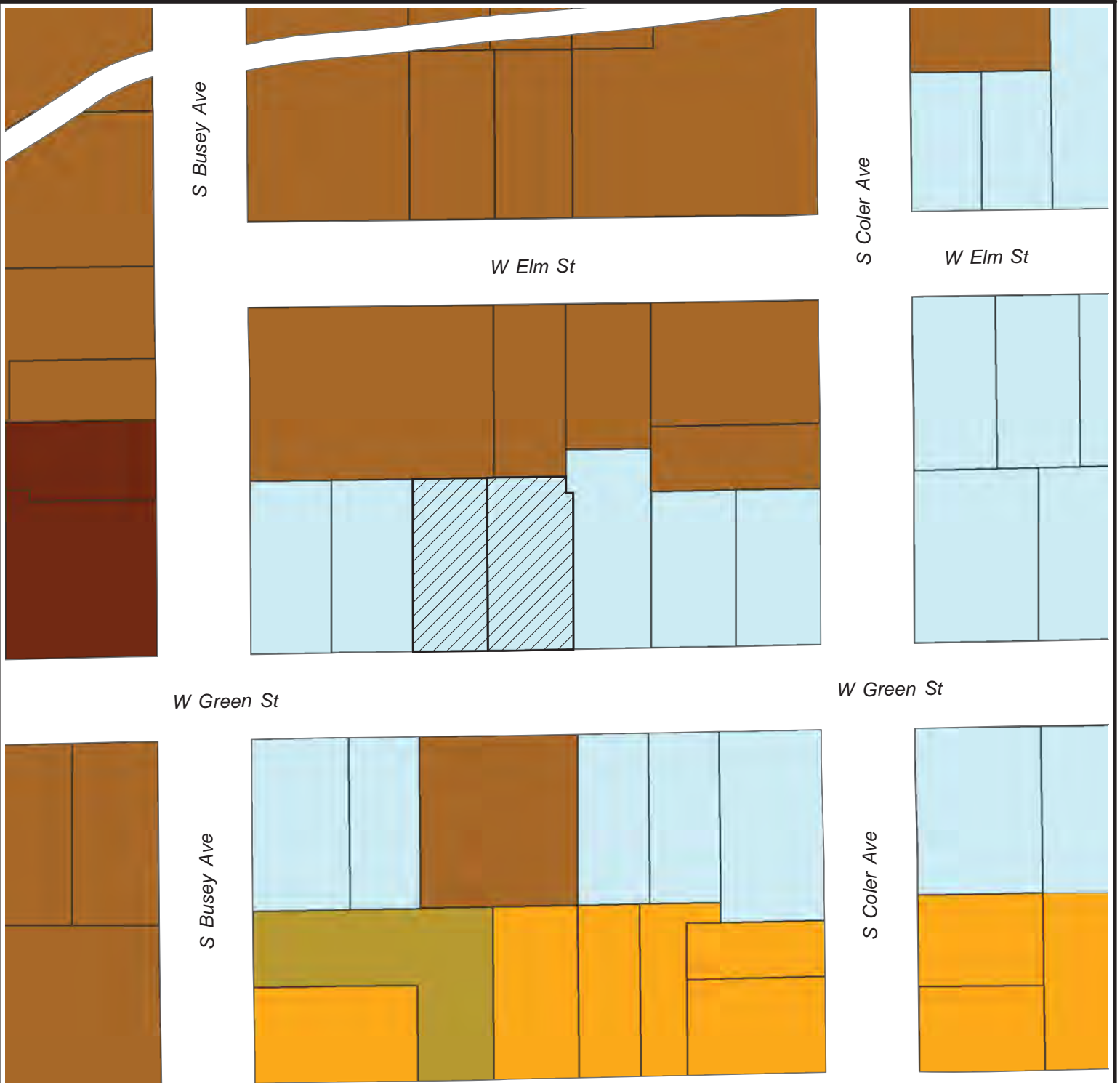

Case: DRB-2016-01
 Subject: MOR Development Review Board Application
 Location: 708 and 710 West Green Street
 Petitioners: Andrew Fell



- MOR
- R3
- R4
- R5
- R6

Exhibit C: Future Land Use Map

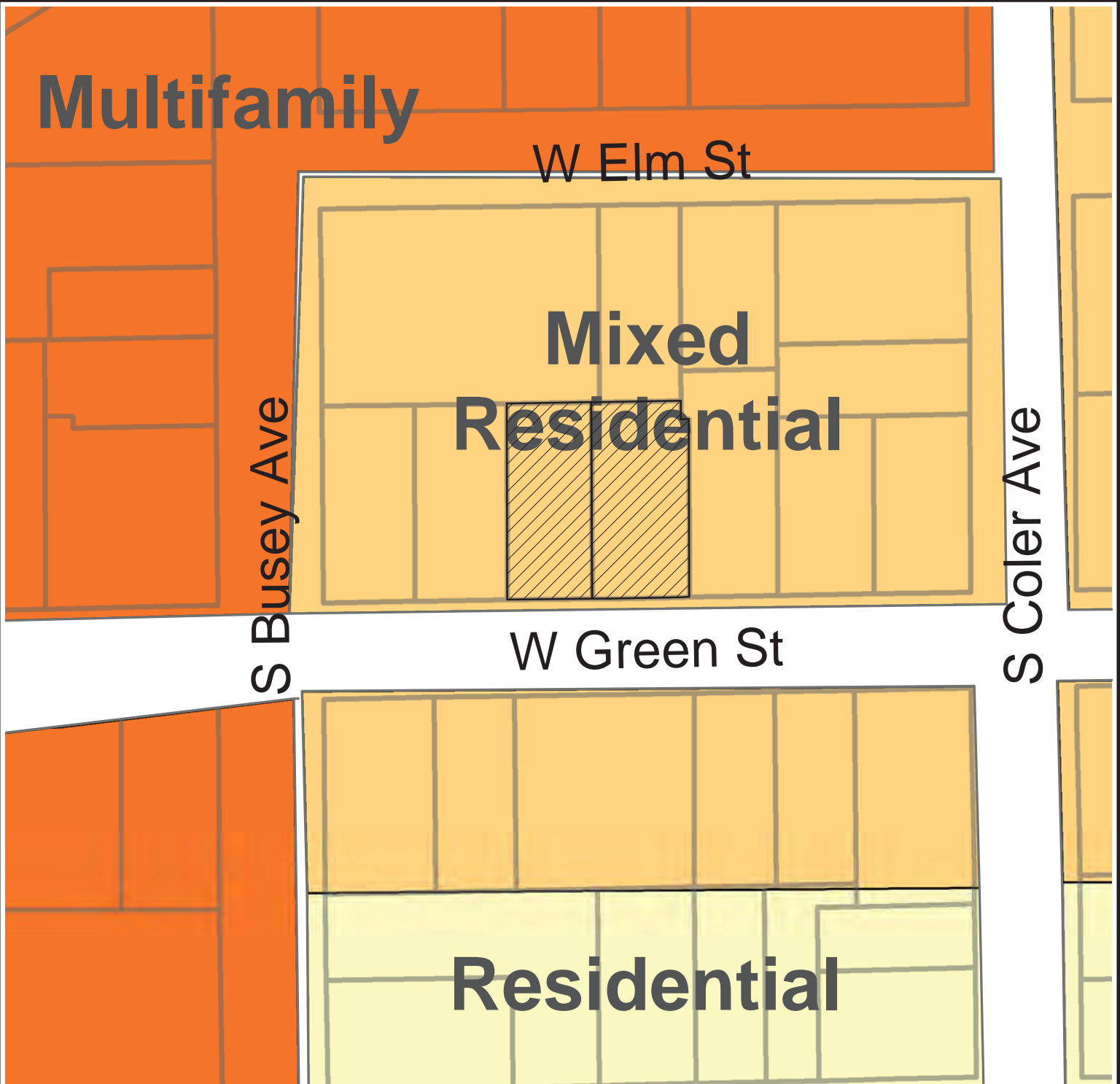

Case: DRB-2016-01
Subject: MOR Development Review Board Application
Location: 708 and 710 West Green Street
Petitioners: Andrew Fell

- Residential
- Mixed Residential
- Multi-Family Residential
- Subject Property



Application for Site Plan Approval in the MOR Zoning District

MOR DEVELOPMENT REVIEW BOARD

BOARD REVIEW FEE - \$150.00 *or* ADMINISTRATIVE REVIEW FEE - \$50.00

The Applicants are responsible for paying the cost of legal publication fees as well. Estimated costs for these fees usually run between \$75.00 to \$225.00. The applicant is billed separately by the News-Gazette.

DO NOT WRITE IN THIS SPACE - FOR OFFICE USE ONLY

Date Request Filed _____ Site Plan Request No. _____
Fee Paid - Check No. _____ Amount _____ Date _____

PLEASE PRINT OR TYPE THE FOLLOWING INFORMATION

1. APPLICANT CONTACT INFORMATION

Name of Applicant(s): **Andrew Fell** Phone: **217-363-2890**
Address (*street/city/state/zip code*): **515 N. Hickory, Suite 101, Champaign, IL 61820**
Email Address: **andrewfell@comcast.net**
Property interest of Applicant(s) (*Owner, Contract Buyer, etc.*):

2. OWNER INFORMATION

Name of Owner(s): **Dr Sohail Chaudry** Phone: **217-377-0232**
Address (*street/city/state/zip code*): **4411 Trorshire Circle, Champaign, IL 61822**
Email Address: **schaudry@gmail.com**
Is this property owned by a Land Trust? Yes No
If yes, please attach a list of all individuals holding an interest in said Trust

NOTE: Applications must be submitted by the owners of more than 50% of the property's ownership

3. PROPERTY INFORMATION

Name of Development Project: **708-710 West Green**
Location of Subject Site: **708-710 West Green Street**
PIN # of Location: **708 = 92-21-17-106-019, 710 = 92-21-17-106-011**
Lot Size: **708 = 55.79' x 121.5', 710 = 53' x 121.5'**

Current Zoning Designation: **MOR**

Current Land Use (*vacant, residence, grocery, factory, etc*): **rental houses**

Proposed Land Use: **708 = 5 unit apartment building, 710 = 6 unit apartment building**

Present Comprehensive Plan Designation: **Mixed Residential**

How does this request conform to the Comprehensive Plan? **The requested development conforms to plan**

Legal Description (*If additional space is needed, please submit on separate sheet of paper*):

See attached.

4. CONSULTANT INFORMATION

Name of Architect(s): Andrew Fell Architecture and Design Phone: **217-363-2890**

Address (*street/city/state/zip code*): **515 N. Hickory, Suite 101, Champaign, IL 61820**

Email Address: **andrewfell@comcast.net**

Name of Engineers(s): BKB Engineering (Bryan Bradshaw) Phone: **217-531-2971**

Address (*street/city/state/zip code*): **301 N. Neil, Suite 400, Champaign, IL 61820**

Email Address: **bbradshaw@bkbeng.com**

Name of Surveyor(s): BKB Engineering Phone: **217-532-2971**

Address (*street/city/state/zip code*): **301 N. Neil, Suite 400, Champaign, IL 61820**

Email Address: **bbradshaw@bkbeng.com**

Name of Professional Site Planner(s): Phone:

Address (*street/city/state/zip code*):

Email Address:

Name of Attorney(s): Phone:

Address (*street/city/state/zip code*):

Email Address:

5. PROPOSED WORK FOR WHICH DESIGN REVIEW IS BEING REQUESTED

Describe and/or illustrate fully the proposed work to be done: *(Plans associated with building permit applications can be referenced. If approval of an addition or detached accessory building is requested, submit a site plan showing the measurements of the lot, the existing buildings and proposed changes and the front, back and side yard setbacks. If approval of a demolition is being requested, submit a site plan of the property and the structure(s) to be demolished.)*

See Attached

6. Is the proposed use Permitted by right in the MOR District or is it a Conditional Use or a Special Use?

The development is permitted by right. No additional waivers or variances are requested with the exception of a waiver to eliminate the requirement to increase the side yard setback for structures over 25' tall. This waiver applies only to the lot line common to 708 and 710. Section VI-5. Yards, F.3.

7. DEVELOPMENT REVIEW

Article XI-12-C of the Zoning Ordinance lists the criteria and standards used by the Development Review Board to review all applications for Site Plan approvals. The following questions concern the design of the proposed Site Plan. ***Attach additional pages if necessary.***

Has the Site Plan been prepared in conformance with the attached Site Plan Checklist?

yes

How does this request conform to the purpose of the MOR Zoning District as stated in Article IV-2 of the Zoning Ordinance?

The request conforms to all parts of Section IV-2 with the exception of the requested waiver above. The new buildings are otherwise constructed by right with no additional requested waivers. The scale of the buildings is kept intentionally small to help blend in and be cohesive with the neighborhood and surrounding structures.

Explain how the proposed use is designed, located and proposed to be operated, so that it will not be unreasonable, injurious or detrimental to the district in which it is located, or otherwise injurious or detrimental to the public welfare.

The existing structures are houses converted to rental properties. The proposed development does not greatly increase the overall number of occupants. Off street parking is provided for all residents.

Explain how the proposed use conforms to the applicable regulations and standards of, and preserves the essential character of, the MOR District, except where such regulations and standards may be modified by the Development Review Board.

The proposed use conforms to all applicable regulations of the MOR district

- 8. Article XI-1-E of the Zoning Ordinance authorizes the Development Review Board to adjust or modify some of the requirements of the Zoning Ordinance in approving a site plan in the MOR Zoning District. The following questions concern the adjustments that may be requested in this Site Plan.

List the Zoning Ordinance requirements that are requested to be adjusted by the Development Review Board:

Section VI Subsection F.3. Page 66 (see attached)
Section _____ Subsection _____ Page _____
Section _____ Subsection _____ Page _____
Section _____ Subsection _____ Page _____

What difficulties or conditions exist on this property that make it difficult to comply with the specific requirements of the Zoning Ordinance and make it necessary to request these Site Plan adjustments?

The lots are non conforming in width. The prescence of the storm sewer on lot 708 decreases the buildable width by 24'. the building on 710 has been place so the setback along the western side is already 10' in an effort to buffer the neighbor as much as possible.

What other reasons justify granting the requested Site Plan adjustment(s)?

The necessity of the parking to be to the north side of the lots, with no other access points other than Green Street requires the north approximately 45' of the lot to be utilized for parking are, reducing the buildable footprint of the lot.

What effects will the requested Site Plan adjustment(s) have on adjacent properties? Further, will such adjustment(s) result in any negative impact or environmental incursions on the adjacent properties and in the vicinity of the proposed Site Plan? If so, please state (or attach) evidence identifying such impacts and proposed solutions to mitigate or reduce the negative impacts resulting from the adjustment(s) requested.

The site plan adjustment has no impact on any neighboring properties. It occurs only at the shared lot line between the two properties.

9. Time schedule for development (*if applicable*):

MOR Approval - July 2016

Construction to begin - October 2016

Completion - July 2017

10. Additional exhibits submitted by the applicant:

See attached

NOTE: If additional space is needed to accurately answer any question, please attach extra pages to the application.

By submitting this application, you are granting permission for City staff to post on the property a temporary yard sign announcing the public hearing to be held for your request.

CERTIFICATION BY THE APPLICANT

I certify all the information contained in this application form or any attachment(s), document(s) or plan(s) submitted herewith are true to the best of my knowledge and belief, and that I am either the property owner or authorized to make this application on the owner's behalf.

Applicant's Signature

Date

PLEASE RETURN THIS FORM ONCE COMPLETED TO:

City of Urbana
Community Development Department Services
Planning Division
400 South Vine Street, Urbana, IL 61801
Phone: (217) 384-2440
Fax: (217) 384-2367

708 – 710 WEST GREEN

ITEM 8.

List the zoning Ordinance requirements that are requested to be adjusted by the Development Review Board:

Section VI – Development Regulations

Subsection – VI-5.F.3.

Page 66

The requested adjustment is to the Open Space Ratio for each property.

Traditionally, a great deal of the open space requirement for a site is situated in the rear yard. Because of the parking requirements and lack of rear access to the site, the ability to get open space on the north side of the buildings is very limited. The front yard setback for each site was reduced to 20' by the Zoning Board of Appeals, but the bulk of each building is actually placed beyond the minimum setback (708 is set at 25'-6" and 710 is set at 25'-4" to the building face) in an effort to be as compatible with the adjacent properties as possible. These requirements and constraints which impact the amount of available open space impact the related resulting the buildable footprint. The additional 3' setback requirement would greatly impact the viability of building layouts.

708 is dramatically impacted by the presence of the storm sewer. Because of the existing storm sewer, the access drive was placed to the far east of this property instead of utilizing a shared drive between the two properties (as is the existing condition).

710 was placed on the site to be compatible with 708 and therefore the distance from the building face to the sidewalk was reduced slightly.

Additionally, this waiver only applies to the common lot line between 708 and 710. No other neighbors will be impacted by this waiver.

708-710 WEST GREEN
ZONING DATA

708 WEST GREEN

LOT AREA = 6,721 SQUARE FEET
TOTAL BUILDING AREA = 3,416 SQUARE FEET

SETBACKS

FRONT: 20' (ZONING VARIANCE: ZBA CASE 2016-MAJOR-03)
SIDE: 7 (17) NO SIDE YARD LESS THAN 7', SUM OF SIDE YARDS =17'
REAR: 10'

MAXIMUM F.A.R. = .7
ACTUAL F.A.R. = 3,416 / 6,721 = .508

MINIMUM O.S.R. = .30
ACTUAL O.S.R. = 1,025 / 3,416 = .30

MAXIMUM BUILDING HEIGHT = 35'
ACTUAL HEIGHT (MEASURED TO MIDLINE OF ROOF) = 34' – 9"

710 WEST GREEN

LOT AREA = 6,413 SQUARE FEET
TOTAL BUILDING AREA = 4,468 SQUARE FEET

SETBACKS

FRONT: 20' (ZONING VARIANCE: ZBA CASE 2016-MAJOR-04)
SIDE: 7 (17) NO SIDE YARD LESS THAN 7', SUM OF SIDE YARDS =17'
REAR: 10'

MAXIMUM F.A.R. = .7
ACTUAL F.A.R. = 4,468 / 6,413 = .696

MINIMUM O.S.R. = .30
ACTUAL O.S.R. = 1,342 / 4,468 = .30

MAXIMUM BUILDING HEIGHT = 35'
ACTUAL HEIGHT (MEASURED TO MIDLINE OF ROOF) = 34' – 9"

AUTOMOBILE PARKING (COMBINED)

REQUIRED = 6 TWO BEDROOM UNITS + 5 ONE BEDROOM UNITS = 11 SPACES
PROVIDED = 12 SPACES (INCLUDING ONE ACCESSIBLE SPACE)

BICYCLE PARKING (COMBINED)

REQUIRED = 1 SPACE PER EVERY 2 UNITS = 6 SPACES
PROVIDED = 8 SPACES

NET

These drawings and specifications are the property and copyright of Andrew Fell. Reproduction or use on any other work except by written agreement with the architect is prohibited. Dimensions shall be verified on field. Do not scale drawings. Only written dimensions shall be used. Design and shall not be used on the job site. Any discrepancy shall be brought to the notice of the Architect prior to the commencement of any work.

ARCHITECTURE AND DESIGN
ANDREW FELL
616 N. HICKORY STREET, SUITE 101
CHAMPAIGN, ILLINOIS 61820
PHONE: 217.282.2890
FAX: 217.282.2893
EMAIL: andrew@andf.com or andf.net

REVISION:

DATE: 16.03.24

PROJECT # 16032

Exhibit E

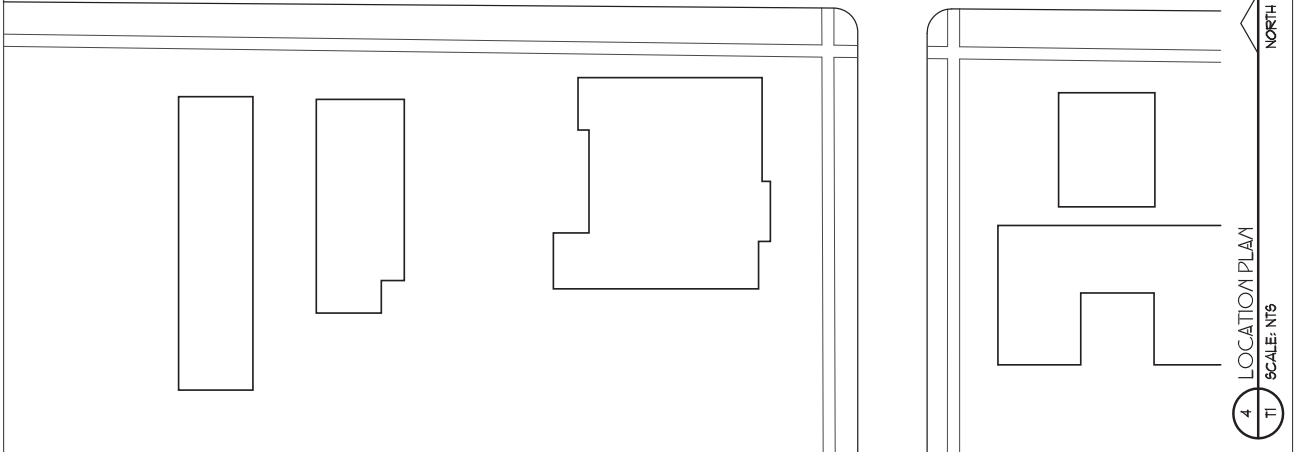
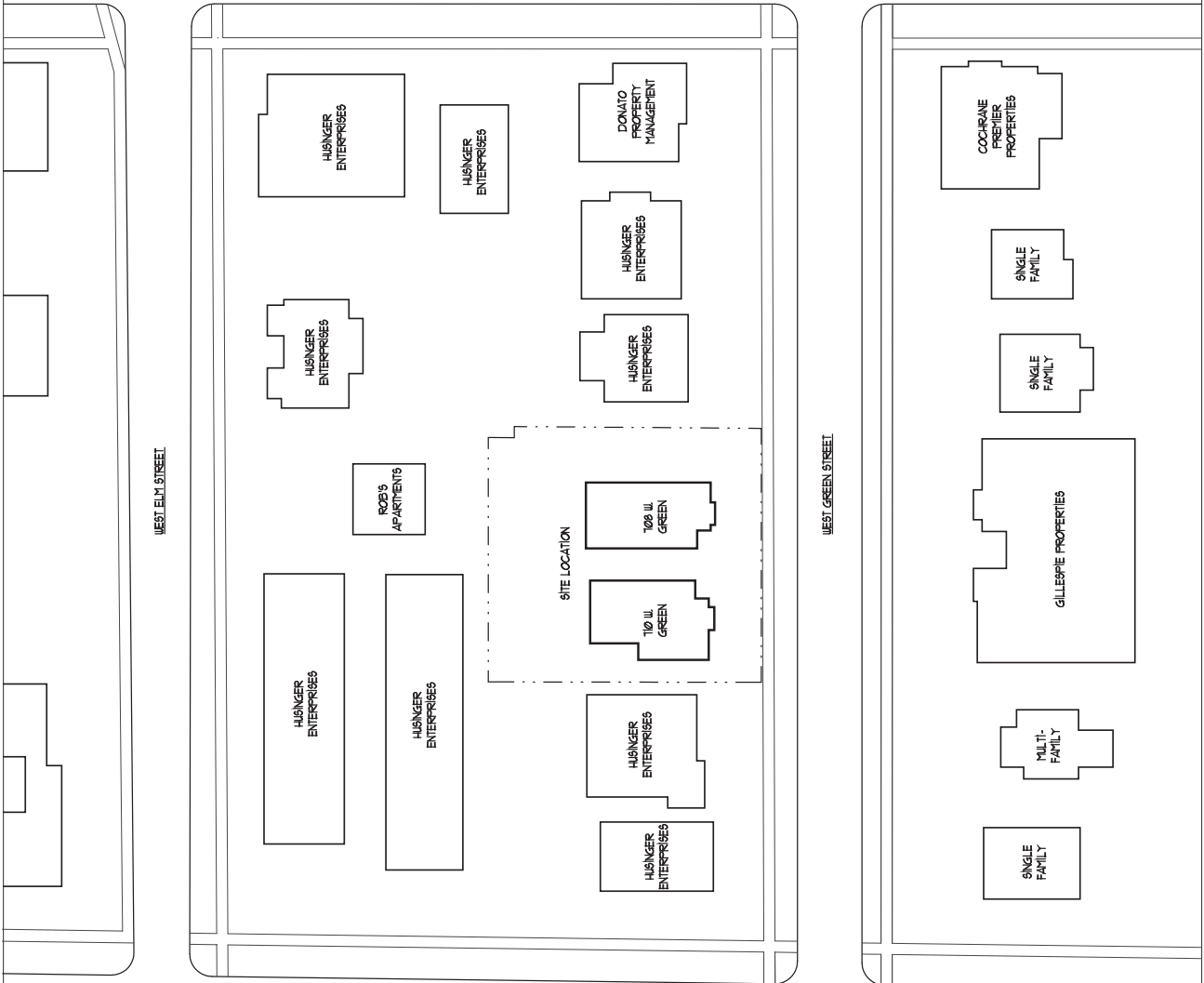
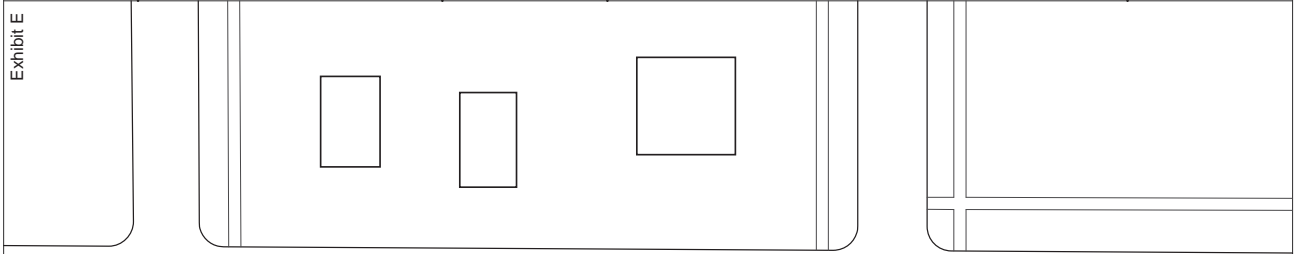

FAR = .01
 MAX ALLOWABLE AREA =
 100 W GREEN = 4,601.1 SF
 100 W GREEN = 4,104.1 SF
 ACTUAL AREA =
 100 W GREEN = 4,468 SF
 100 W GREEN = 3,446 SF

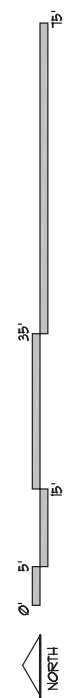
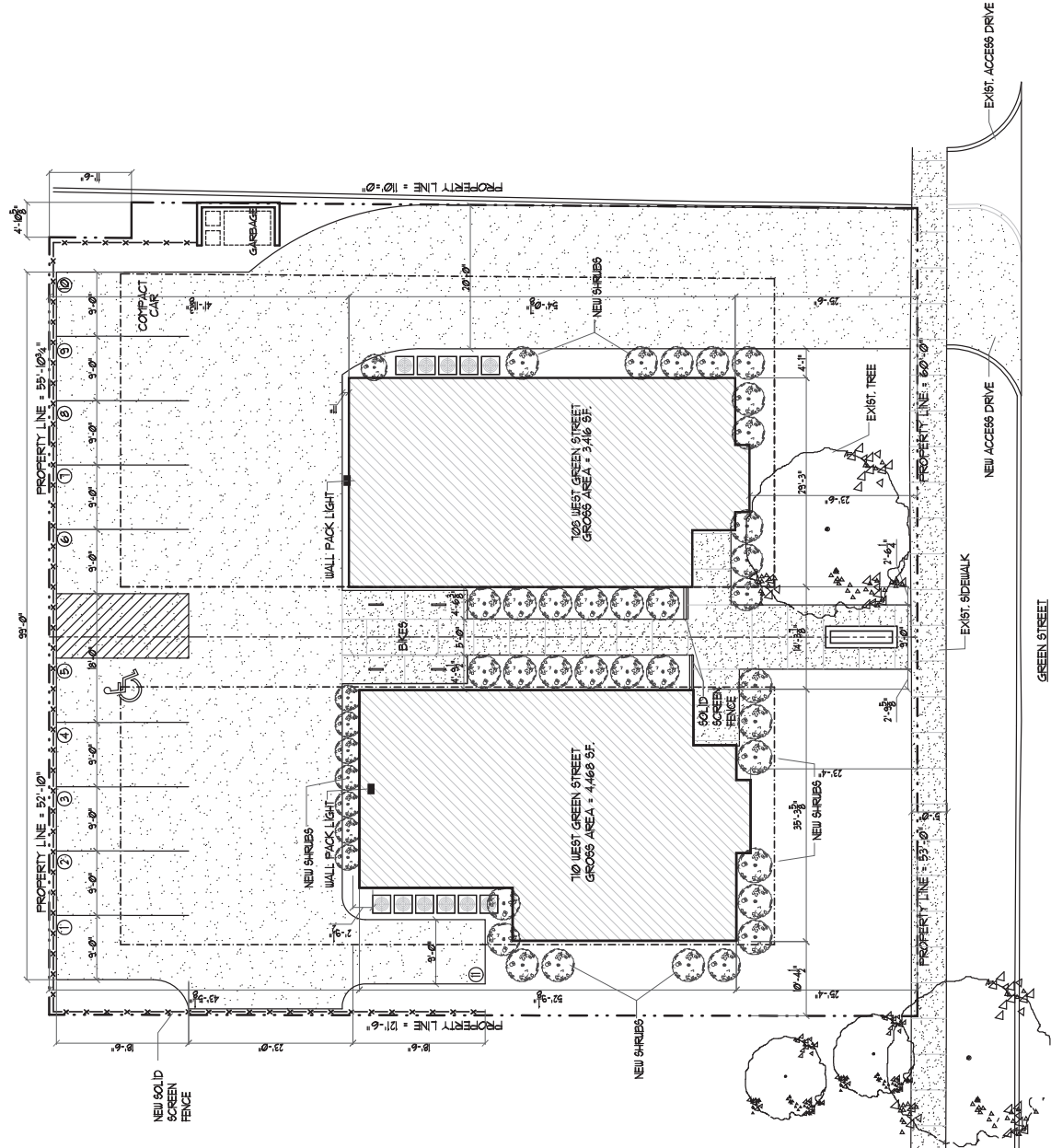

4 SITE PLAN
 51 SCALE: 1/8" = 1'-0"

Exhibit E

PROJECT # 16032
 DATE: 10.06.14
 REVISED:

A N D R E W F E L L
ARCHITECTURE AND DESIGN
 616 N. HICKORY STREET, SUITE 101
 CHAMPAIGN, ILLINOIS 61820
 PHONE: 217.253.2890
 FAX: 217.253.2893
 EMAIL: andrewf@andrewfell.com

These drawings and specifications are the property and copyright of Andrew Fell Architecture and shall not be used on any other work except by written agreement with the architect. Design and shall not be used on any other work except by written agreement with the architect. Dimensions shall be verified on the job site. Any discrepancy shall be brought to the notice of the architect prior to the commencement of any work.

708-710 WEST GREEN STREET
 NEW CONSTRUCTION
 URBANA, IL 61801

11

2

708-710 WEST GREEN STREET
NEW CONSTRUCTION
URBANA, IL 61801

ARCHITECTURE AND DESIGN
616 N. HICKORY STREET, SUITE 101
CHAMPAIGN, ILLINOIS 61820
PHONE: 217.282.2880
FAX: 217.282.8483
EMAIL: ondrew@andrewfell.com

PROJECT # 16032
DATE: 16.03.24
REVISION:

These drawings and specifications are the property and copyright of Andrew Fell Architecture and Design. No other work, except by written agreement with the architect, shall be brought to the notice of the architect prior to the commencement of any work. Dimensions shall be verified on field. Do not scale drawings. Only written dimensions shall be used. Design and shall not be used on any other work except by written agreement with the architect.

Exhibit E

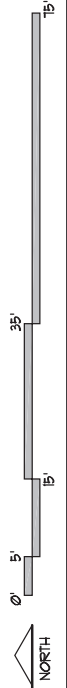
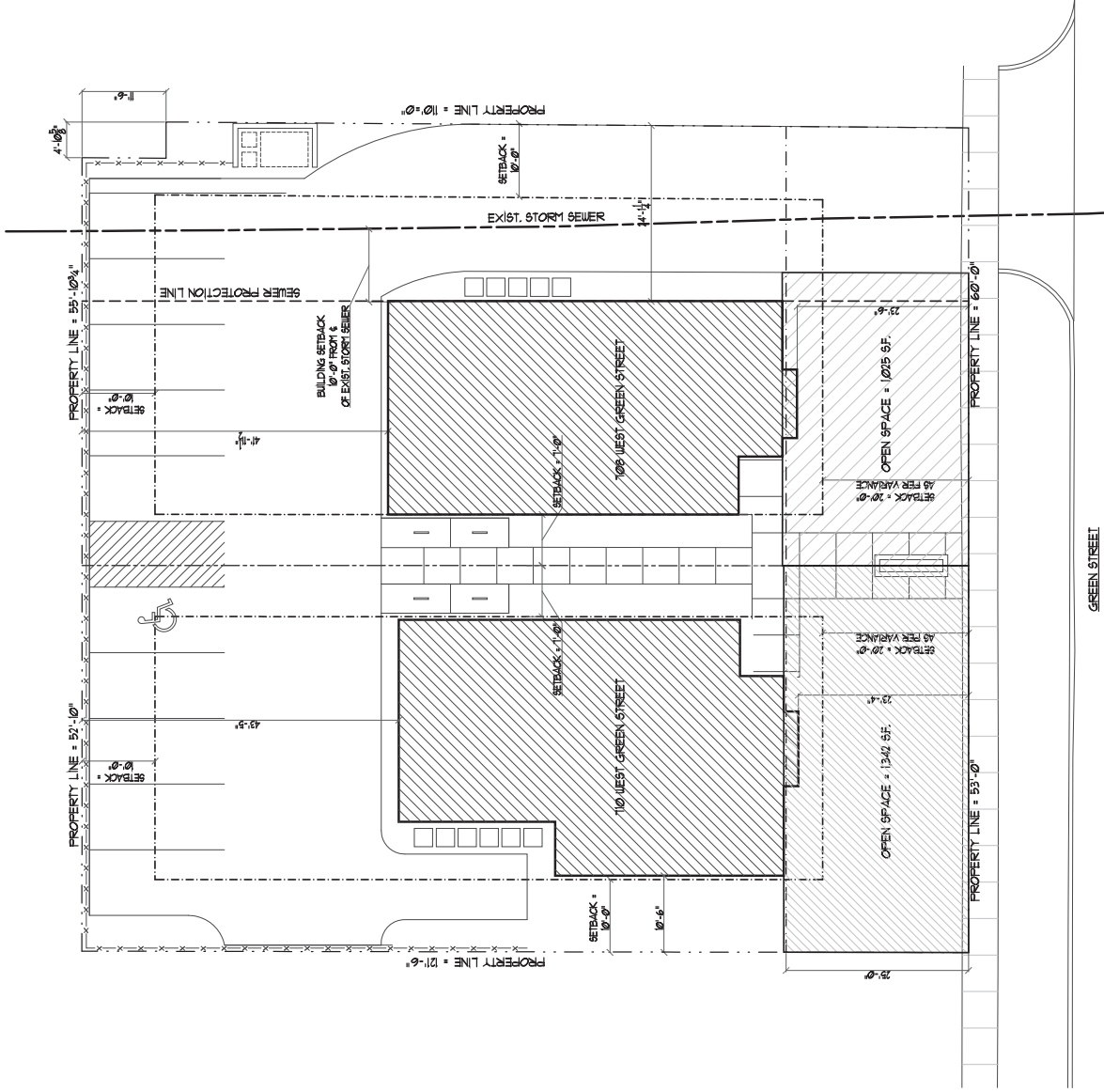

4 SETBACK PLAN
SCALE: 1/8" = 1'-0"

These drawings and specifications are the property and copyright of Andrew P. & Associates and any other work except by written agreement with the architect. Design and shall not be used on the job site. Any discrepancy between dimensions shall be resolved by written dimensions and be lead. Do not scale drawings. Dimensions shall be verified on the architect prior to the commencement of any work.

Exhibit E

708 W. GREEN

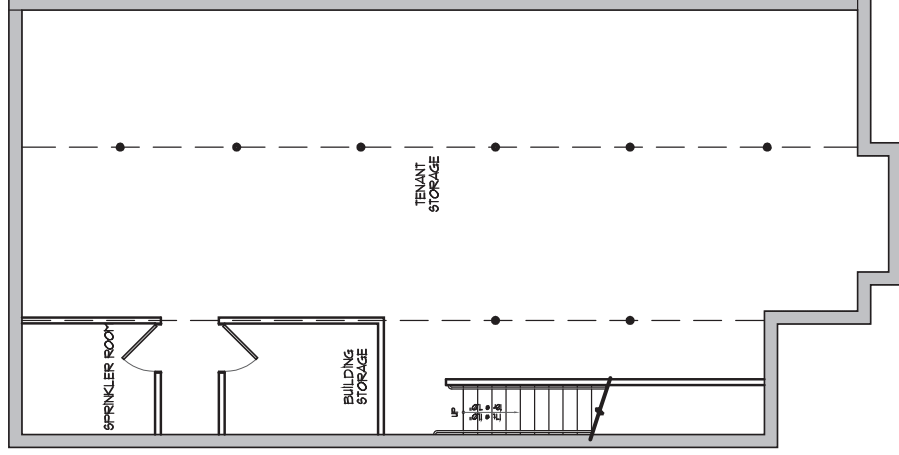

710 W. GREEN

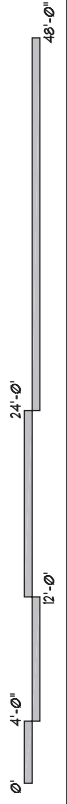
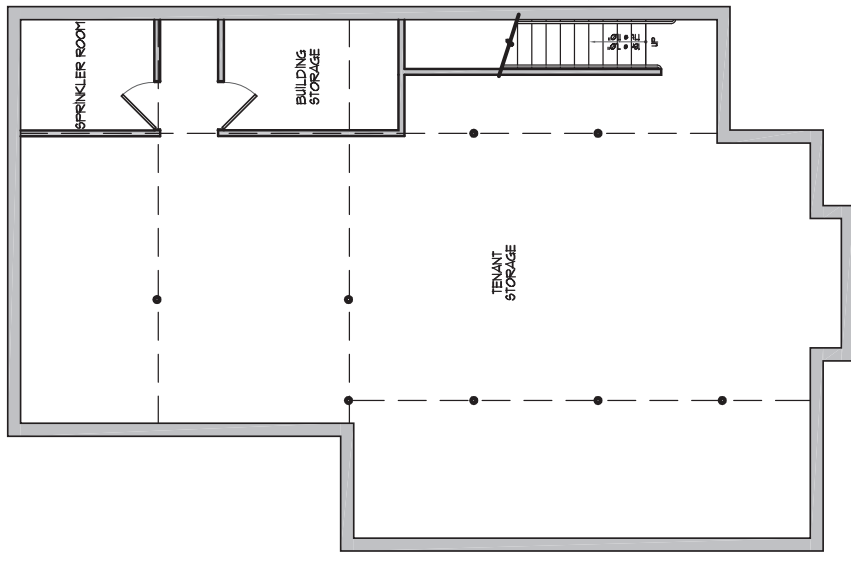

Exhibit E

PROJECT # 16032
DATE: 16.03.24
REV: 01/

A R C H I T E C T U R E A N D D E S I G N
A N D R E W F E L L
616 N. HICKORY STREET, SUITE 101
CHAMPAIGN, ILLINOIS 61820
PHONE: 217.282.2880
FAX: 217.282.2483
EMAIL: andrewfell@comcast.net

These drawings and specifications are the property and copyright of Andrew Fell. Reproduction or other use without the architect's approval is prohibited. Design and shall not be used on any other work except by written agreement with the architect. Only written dimensions shall be used. Do not scale drawings. Dimensions shall be verified on the job site. Any discrepancy shall be brought to the notice of the Architect prior to the commencement of any work.

708-710 W/ST GREEN/STREET
NEW CONSTRUCTION
URBANA, IL 61801

A2

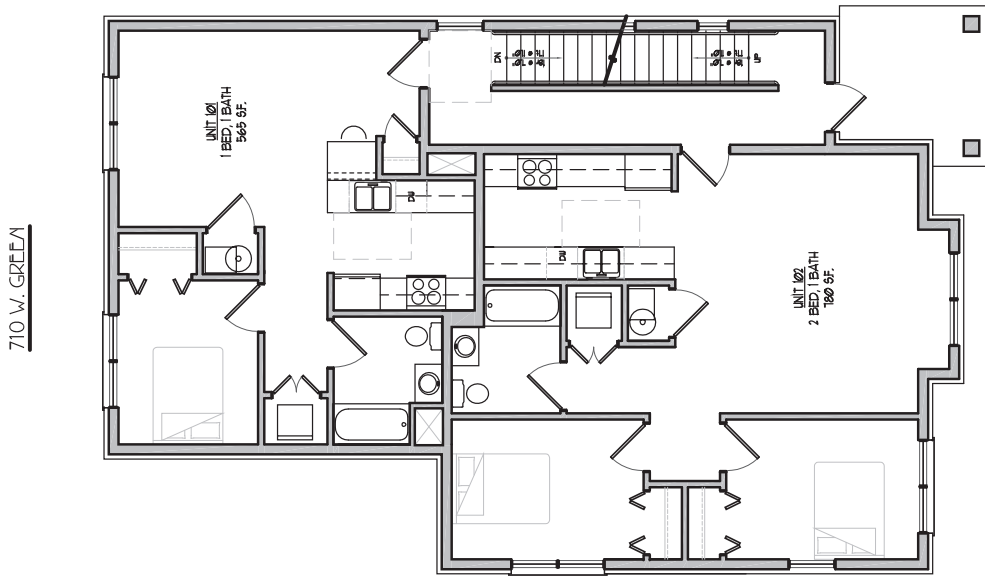
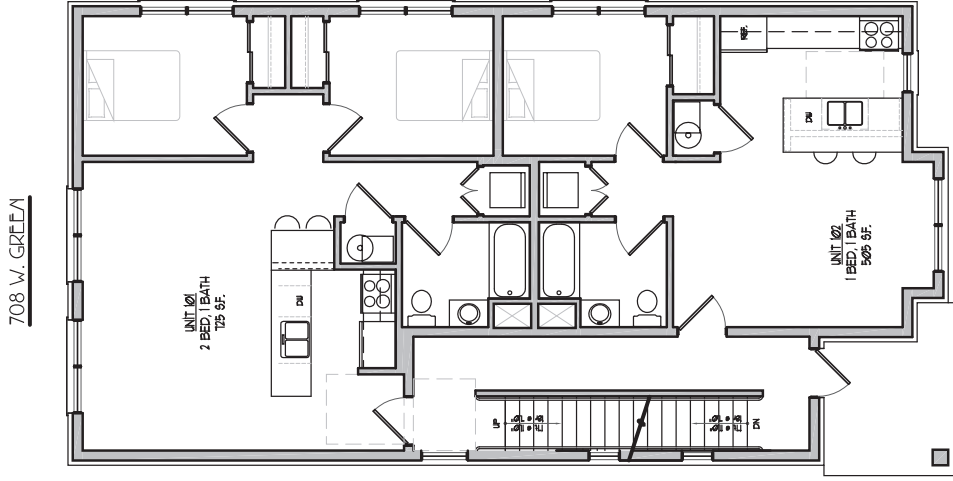

48'-0"

24'-0"

12'-0"

4'-0"

0'



4 FIR/T FLOOR PLAN
SCALE: 1/8" = 1'-0"

A2

Exhibit E

PROJECT # 16032
DATE: 16.03.24
REV: 01/

A R C H I T E C T U R E A N D D E S I G N
A N D R E W F E L L
616 N. HICKORY STREET, SUITE 101
CHALMERS, ILLINOIS 61820
PHONE: 217.282.2880
FAX: 217.282.2483
EMAIL: andrewfell@comcast.net

These drawings and specifications are the property and copyright of Andrew Fell. Reproduction or other use without the architect's agreement with the architect is prohibited. Design and shall not be used on any other work except by written permission from the architect. Only written dimensions shall be used. Do not scale drawings. Dimensions shall be verified on the job site. Any discrepancy shall be brought to the notice of the Architect prior to the commencement of any work.

708-710 W. GREEN STREET
NEW CONSTRUCTION
URBANA, IL 61801

A3

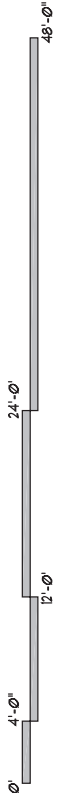
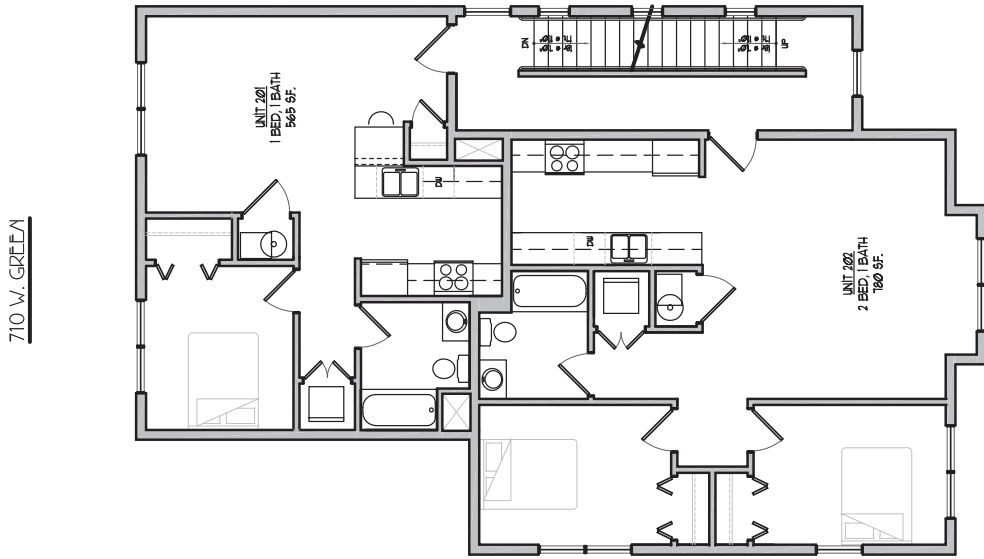
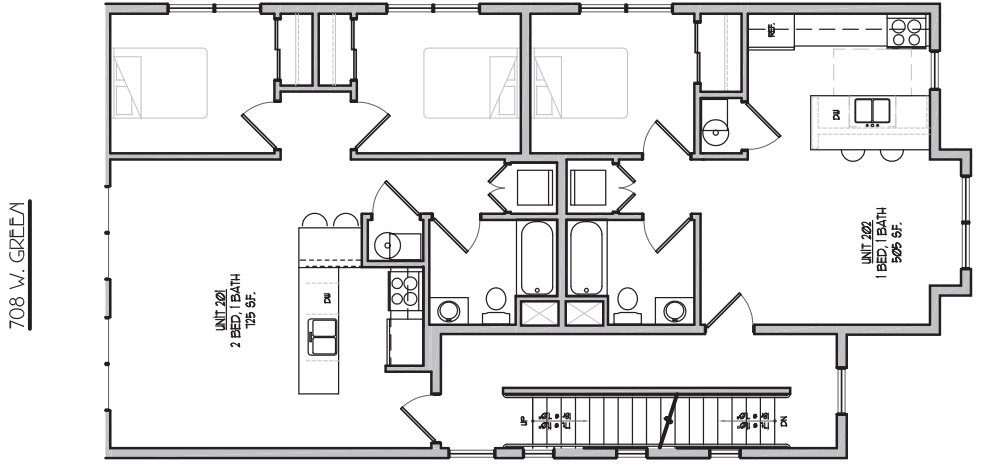

NORTH

4 SECOND FLOOR PLAN
SCALE: 1/8" = 1'-0"

These drawings and specifications are the property and copyright of Andrew P. Architecture and Design. No part of these drawings or other work except by written agreement with the architect shall be brought to the notice of the Architect prior to the commencement of any work.

Exhibit E

708 W. GREEN

710 W. GREEN

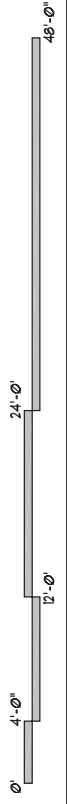
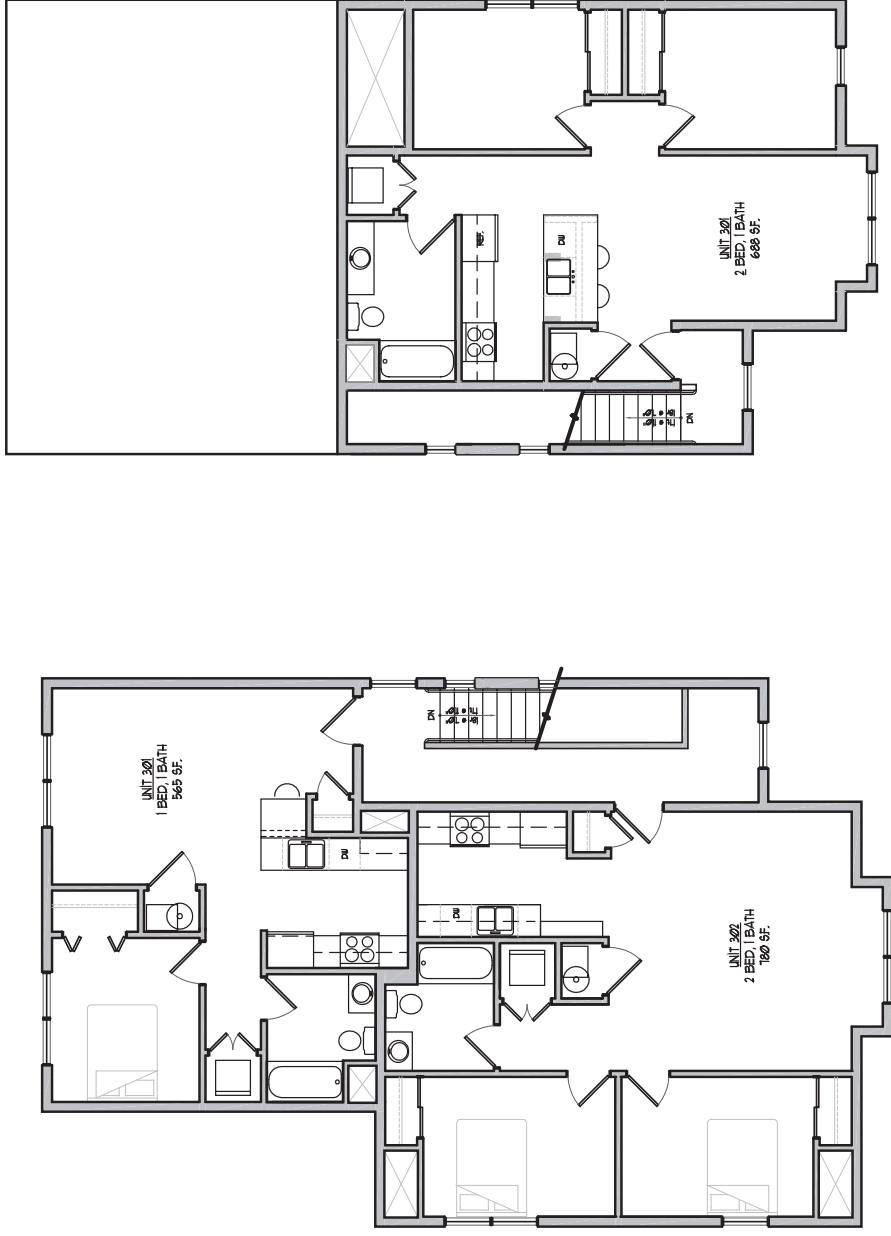

708-710 W/ T GREEN / STREET
NEW CONSTRUCTION
URBANA, IL 61801

ARCHITECTURE AND DESIGN
616 N. HICKORY STREET, SUITE 101
CHAMPAIGN, ILLINOIS 61820
PHONE: 217.282.2880
FAX: 217.282.4843
EMAIL: ondrew@architect.net

These drawings and specifications are the property and copyright of Andrew Fell. All structures and design shall not be used on any other work except by written agreement with the architect. Dimensions shall be verified on the job site. Any discrepancy shall be brought to the notice of the Architect prior to the commencement of any work.

PROJECT # 16032
DATE: 16.03.24
REVISED:

Exhibit E

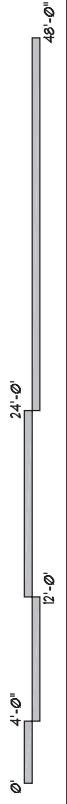
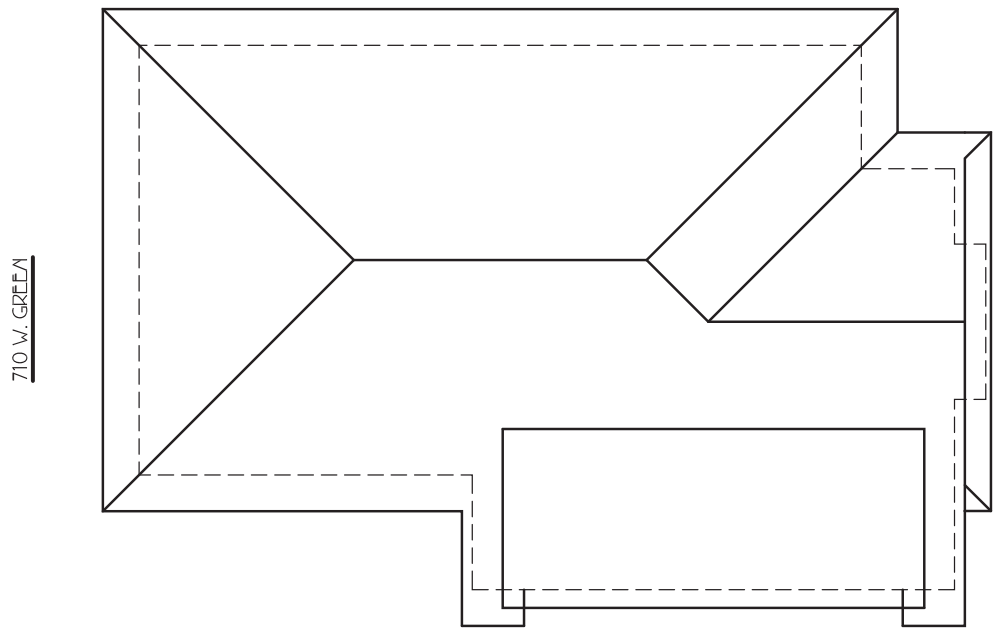
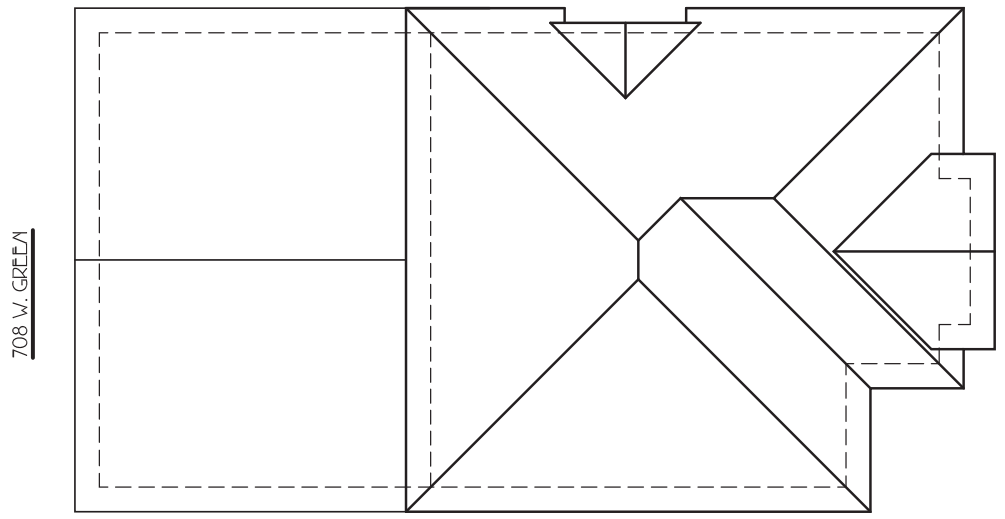

4 ROOF PLAN
SCALE: 1/8" = 1'-0"

Exhibit E

710 W. GREEN

708 W. GREEN

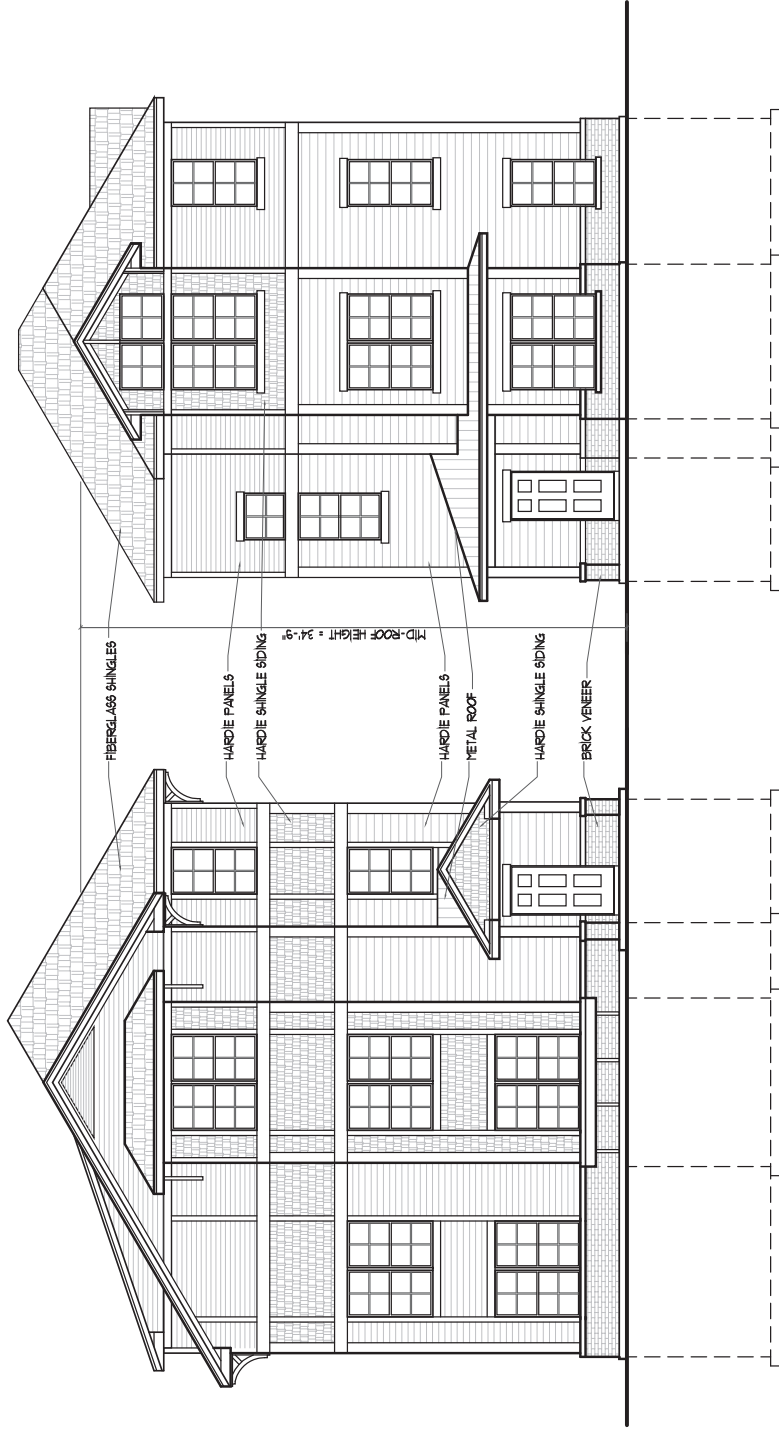

FIBERGLASS SHINGLES

HARDIE PANELS

HARDIE SHINGLE SIDING

MID-ROOF HEIGHT = 34'-9"

HARDIE PANELS

METAL ROOF

HARDIE SHINGLE SIDING

BRICK VENEER

4 SOUTH ELEVATION
SCALE: 1/8" = 1'-0"

0' 4'-0" 24'-0" 48'-0"

PROJECT # 16032
DATE: 16.03.24
REV: 01/

A N D R E W F E L L
ARCHITECTURE AND DESIGN
616 N. HICKORY STREET, SUITE 101
CHAMPAIGN, ILLINOIS 61820
PHONE: 217.282.2880
FAX: 217.282.2483
EMAIL: andrewfell@comcast.net

These drawings and specifications are the property and copyright of Andrew Fell Architecture and shall not be used on any other work except by written agreement with the architect. Dimensions shall be verified on the job site. Any discrepancy shall be brought to the notice of the Architect prior to the commencement of any work.

708-710 W/ T GREEN/ STREET
NEW CONSTRUCTION
URBANA, IL 61801

A6

These drawings and specifications are the property and copyright of Andrew P. Architecture and any other work except by written agreement with the architect shall be brought to the notice of the architect prior to the commencement of any work.

Exhibit E

710 W. GREEN

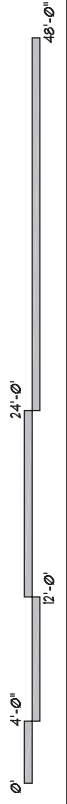
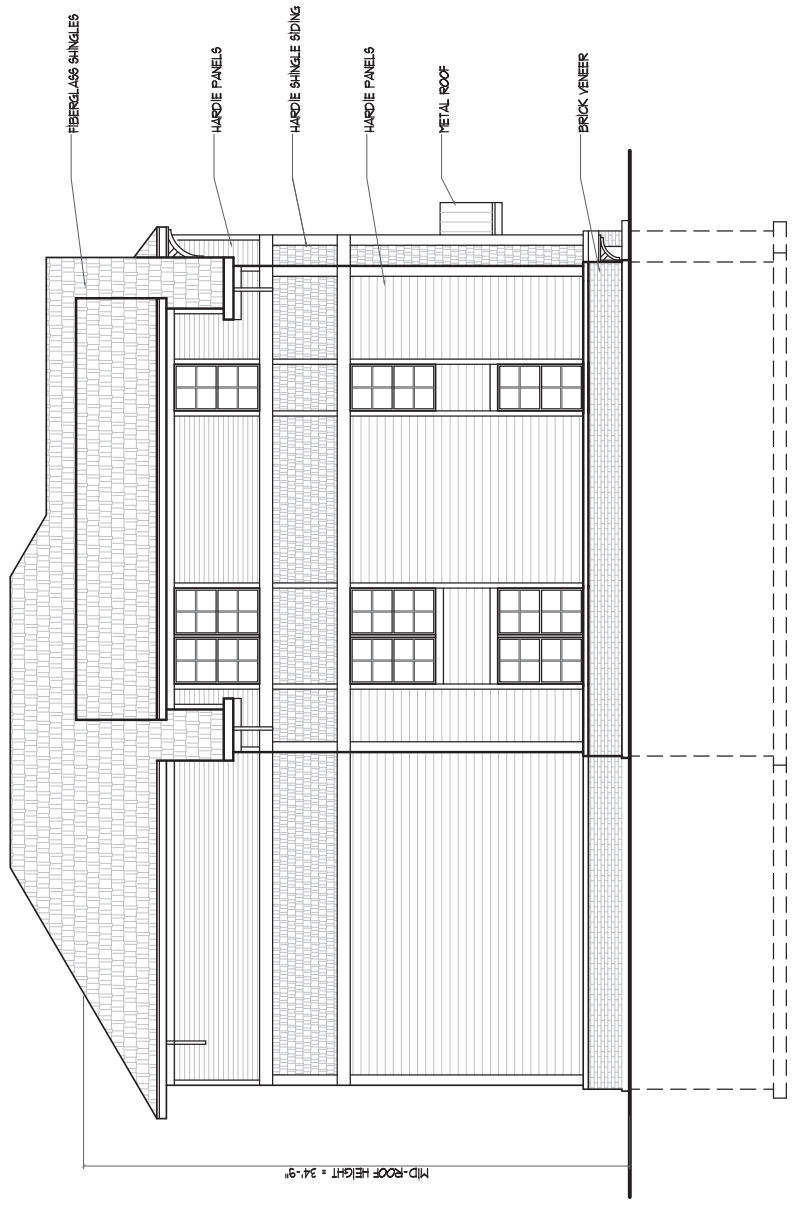

4 WEST ELEVATION
SCALE: 1/8" = 1'-0"

These drawings and specifications are the property and copyright of Andrew Fell and shall not be used on any other work except by written agreement with the architect. Dimensions shall be verified on the job site. Any discrepancy shall be brought to the notice of the Architect prior to the commencement of any work.

Exhibit E

708 W. GREEN

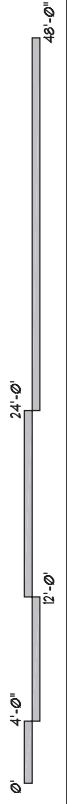
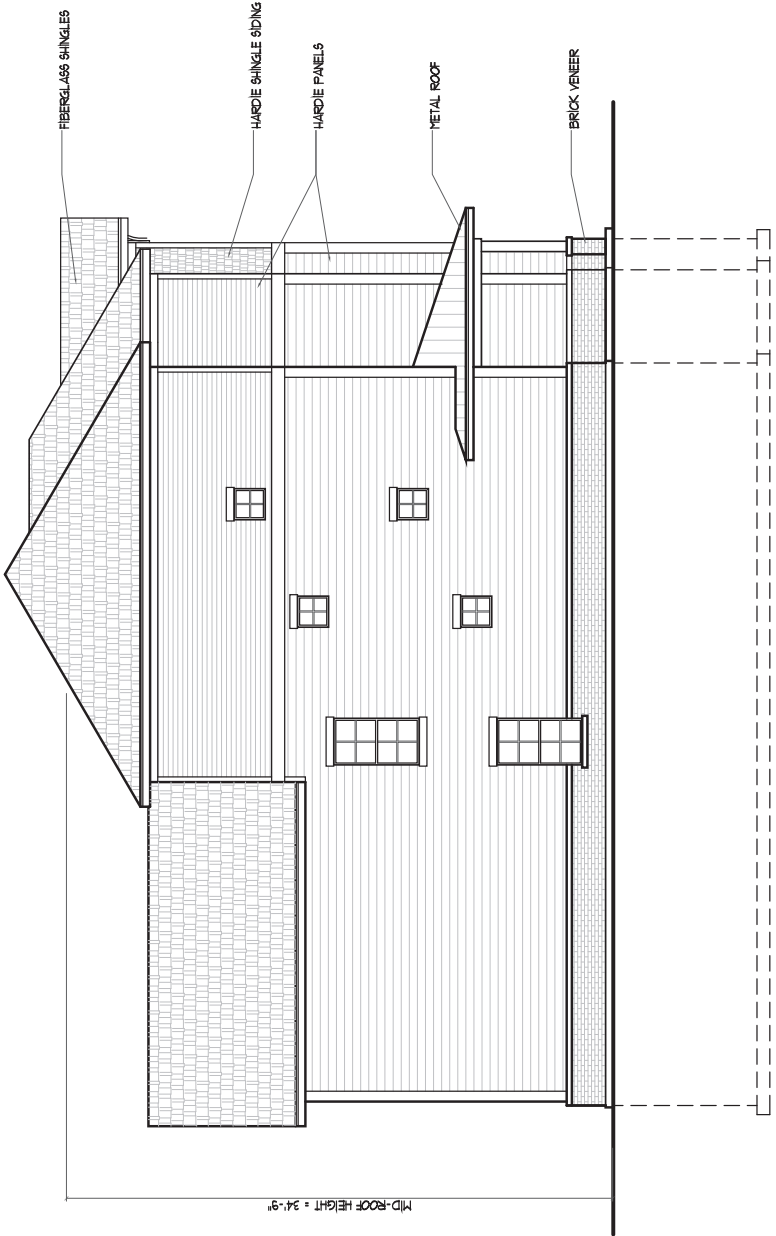

4 WEST ELEVATION
SCALE: 1/8" = 1'-0"

Exhibit E

710 W. GREEN

708 W. GREEN

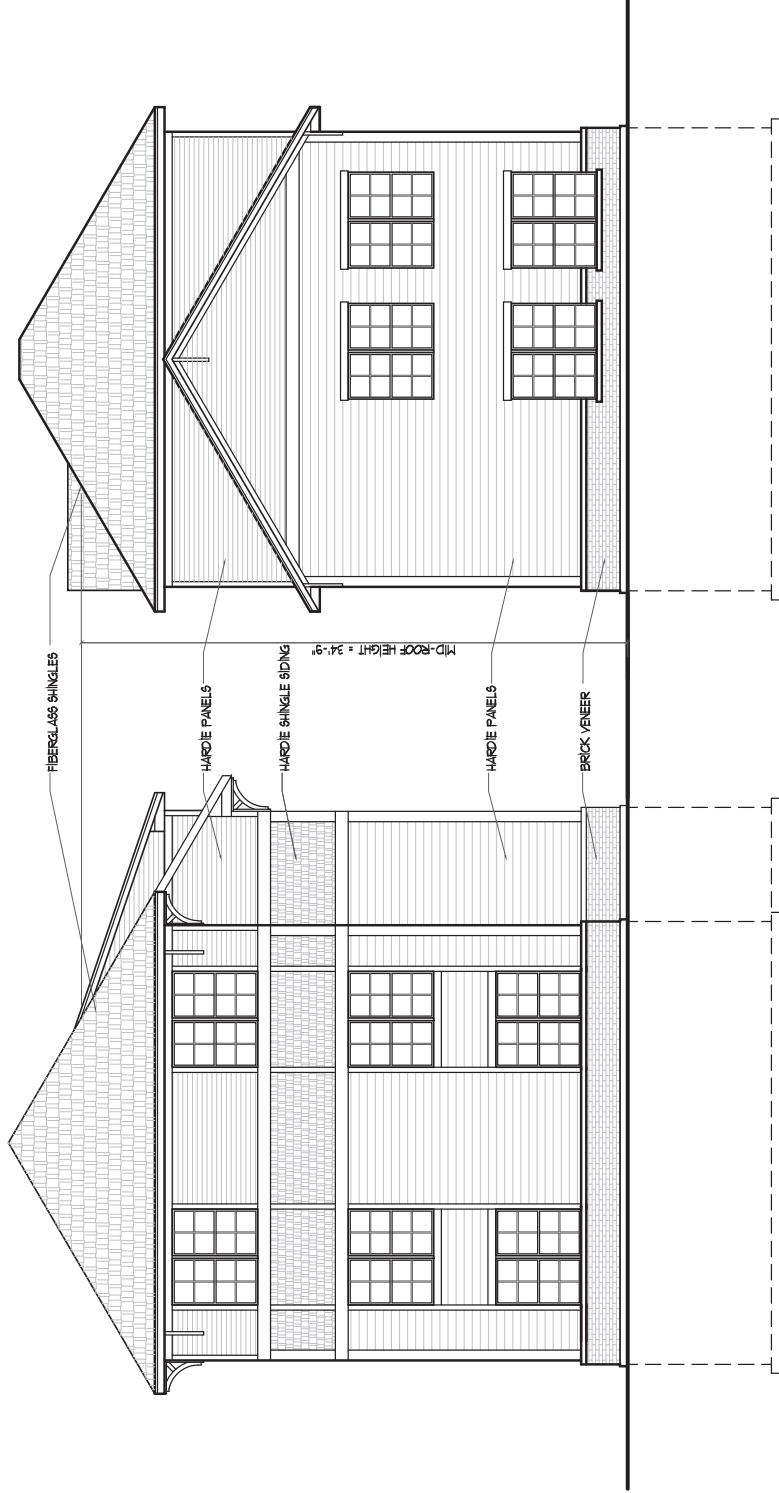

4 NORTH ELEVATION
 SCALE: 1/8" = 1'-0"

0' 4'-0" 24'-0" 48'-0"

708-710 W/ST GREEN/STREET
 NEW CONSTRUCTION
 URBANA, IL 61801

A9

ANDREW FELL
 ARCHITECTURE AND DESIGN
 616 N. HICKORY STREET, SUITE 101
 CHAMPAIGN, ILLINOIS 61820
 PHONE: 217.282.2880
 FAX: 217.282.2483
 EMAIL: andrew@afdesign.net

PROJECT # 16032
 DATE: 16.03.24
 REV/NOV:

These drawings and specifications are the property and copyright of Andrew Fell Architecture and shall not be used on any other work except by written agreement with the architect. Only written dimensions shall be used. Do not scale drawings. Dimensions shall be verified on the job site. Any discrepancy shall be brought to the notice of the Architect prior to the commencement of any work.

1/8"=1'

Exhibit E

PROJECT # 16032
DATE: 16.03.24
REV: 01

A N D R E W F E L L
ARCHITECTURE AND DESIGN
616 N. HICKORY STREET, SUITE 101
CHAMPAIGN, ILLINOIS 61820
PHONE: 217.282.8483
FAX: 217.282.8483
EMAIL: andrewfell@comcast.net

These drawings and specifications are the property and copyright of Andrew Fell Architecture and any other work except by written agreement with the architect. Design and shall not be used on any other work except by written agreement with the architect. Dimensions shall be verified on the job site. Any discrepancy shall be brought to the notice of the Architect prior to the commencement of any work.

708-710 W. GREEN STREET
NEW CONSTRUCTION
URBANA, IL 61801

A10

710 W. GREEN

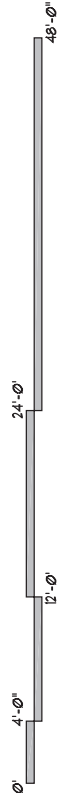
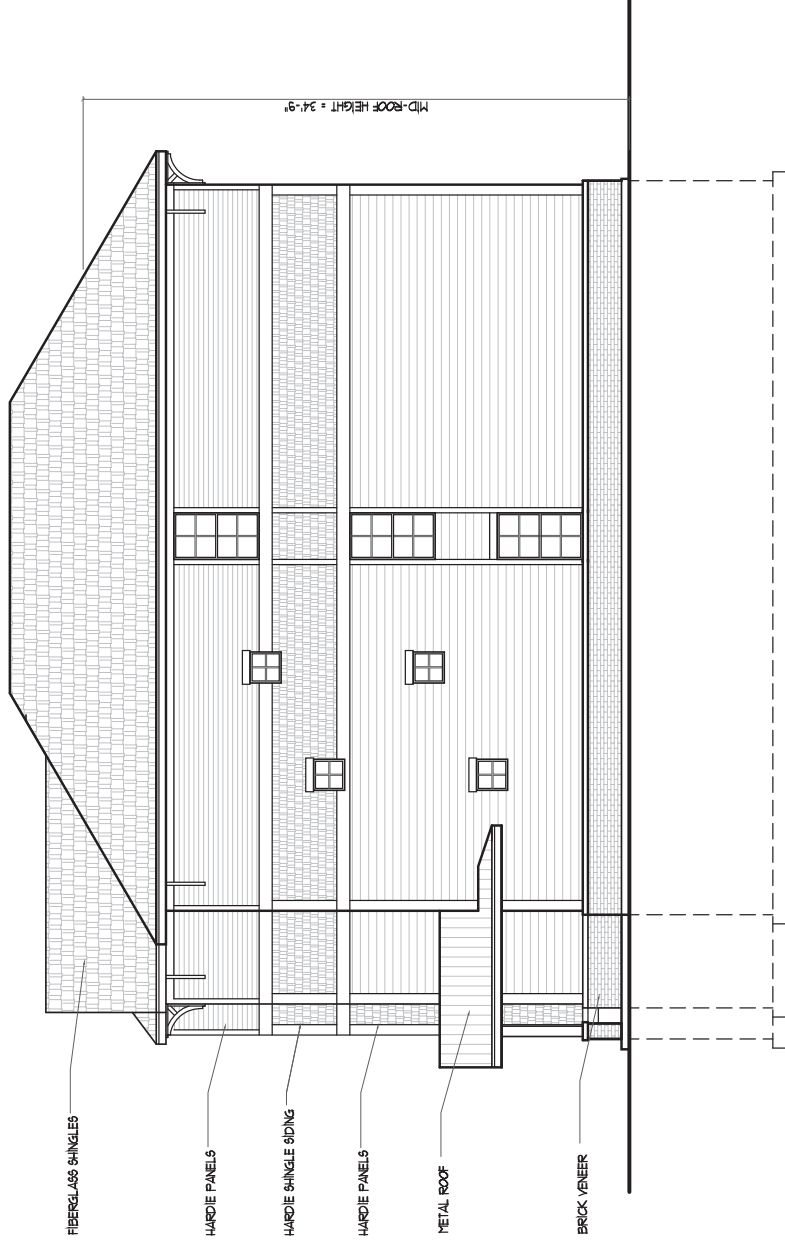

4 EAST ELEVATION
SCALE: 1/8" = 1'-0"

Exhibit E

PROJECT # 16032
DATE: 16.03.24
REV: 01

A N D R E W F E L L
ARCHITECTURE AND DESIGN
616 N. HICKORY STREET, SUITE 101
CHAMPAIGN, ILLINOIS 61820
PHONE: 217.282.2880
FAX: 217.282.4843
EMAIL: andrewfell@comcast.net

These drawings and specifications are the property and copyright of Andrew Fell Architecture and Design. No part of these drawings or specifications shall be reproduced, stored in a retrieval system, or transmitted in any form or by any means, electronic, mechanical, photocopying, recording, or by any information storage and retrieval system, without the prior written consent of Andrew Fell Architecture and Design. Dimensions shall be verified on the job site. Any discrepancy between the drawings and the job site shall be the responsibility of the Architect prior to the commencement of any work.

708-710 W/ T GREEN / STREET
NEW CONSTRUCTION
URBANA, IL 61801

A11

708 W. GREEN

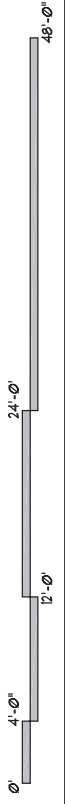
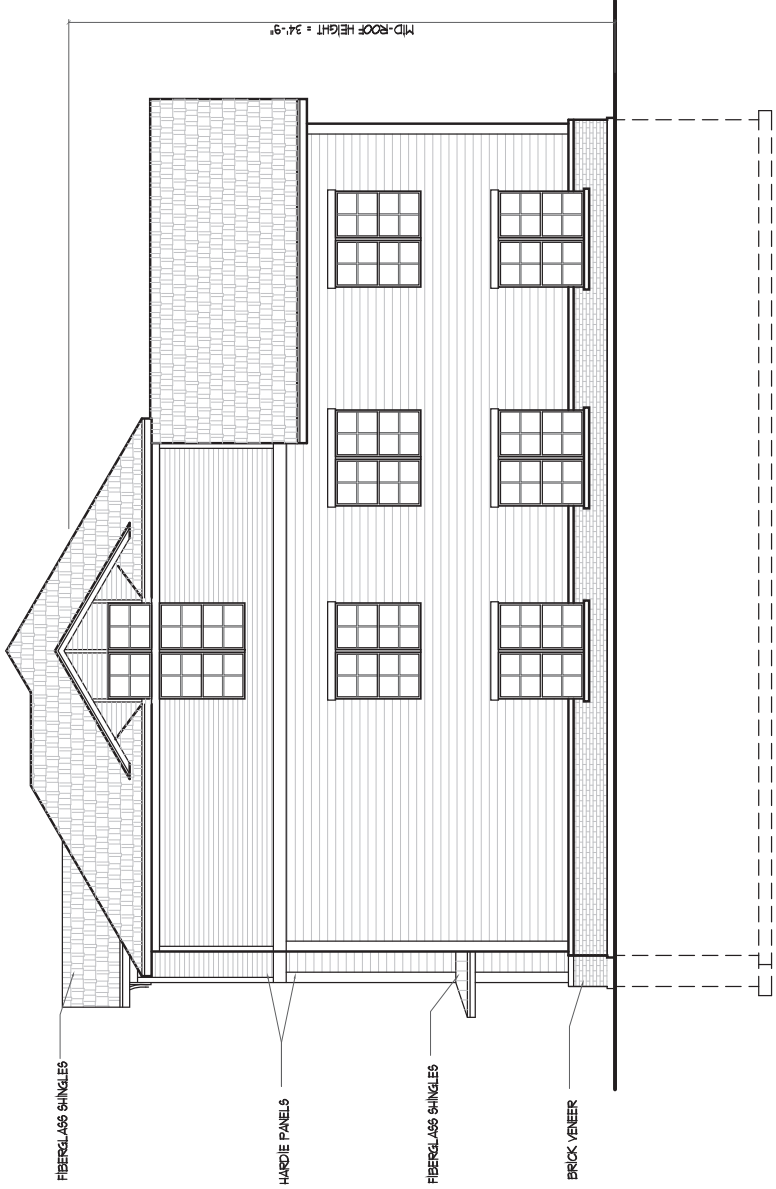

4 EAST ELEVATION
SCALE: 1/8" = 1'-0"

A11



Exhibit F: Area Photos



708 West Green Street



710 West Green Street